



COMUNE DI BARGA - REGOLAMENTO URBANISTICO
ALLEGATO "B" ALLE NORME TECNICHE DI ATTUAZIONE
DISCIPLINA DEI CENTRI STORICI
ABACO DI RIFERIMENTO PER I CENTRI STORICI



ELEMENTO DI FACCIATA
SPECIFICHE

ZOCCOLO

N° EL. 01

schema grafico esempio 1

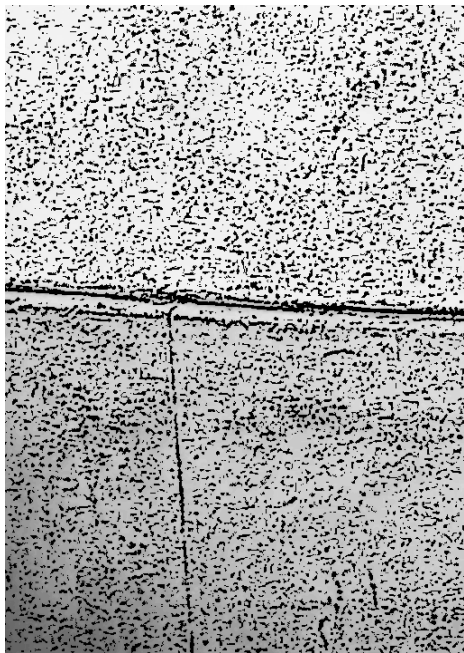

testo:

schema grafico esempio 2

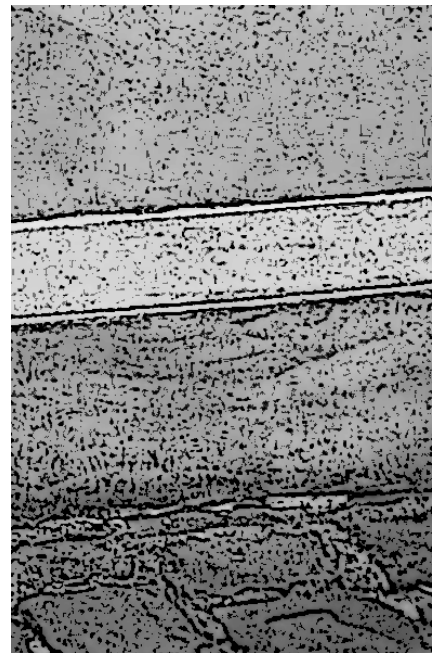

testo:

schema grafico esempio 3

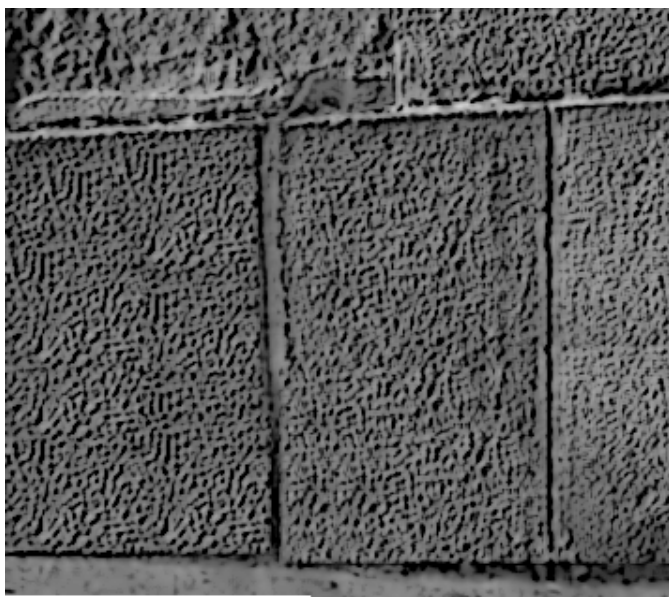

testo:

schema grafico esempio 4

testo:



**COMUNE DI BARGA - REGOLAMENTO URBANISTICO
ALLEGATO "B" ALLE NORME TECNICHE DI ATTUAZIONE
DISCIPLINA DEI CENTRI STORICI
ABACO DI RIFERIMENTO PER I CENTRI STORICI**



**ELEMENTO DI FACCIATA
SPECIFICHE**

SCALE ESTERNE

N° EL. 03

schema grafico esempio 1

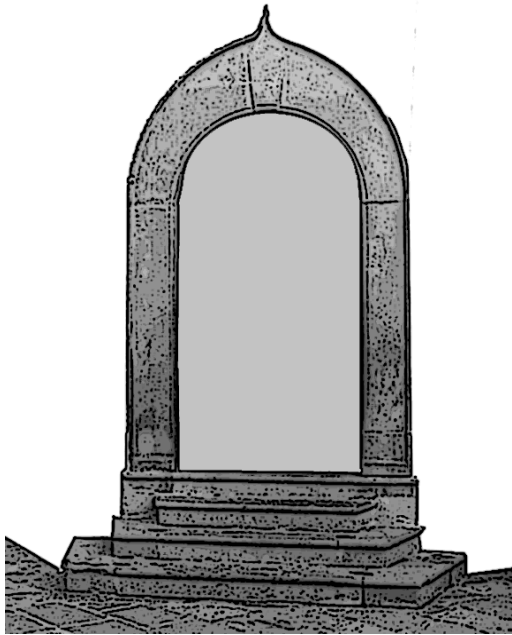

testo:

schema grafico esempio 2



testo:

schema grafico esempio 3

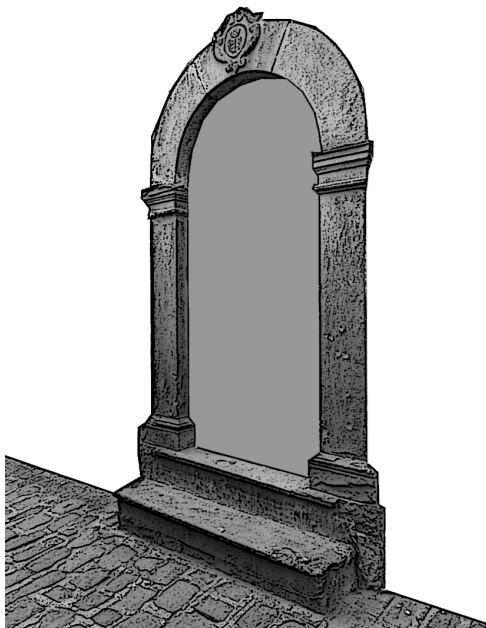

testo:

schema grafico esempio 4

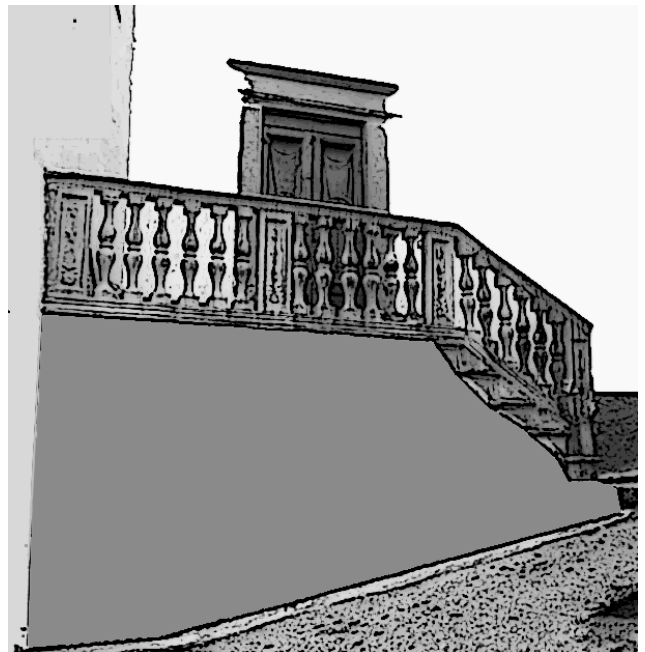

testo:



**COMUNE DI BARGA - REGOLAMENTO URBANISTICO
ALLEGATO "B" ALLE NORME TECNICHE DI ATTUAZIONE
DISCIPLINA DEI CENTRI STORICI
ABACO DI RIFERIMENTO PER I CENTRI STORICI**



**ELEMENTO DI FACCIATA
SPECIFICHE**

SCALE ESTERNE

N° EL. 03

schema grafico esempio 5



testo:

schema grafico esempio 6



testo:

schema grafico esempio 7

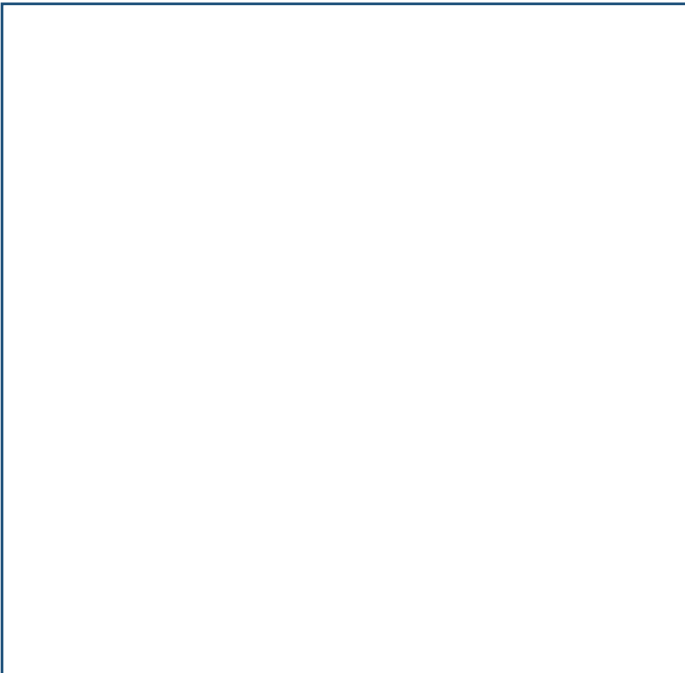

testo:

schema grafico esempio 8

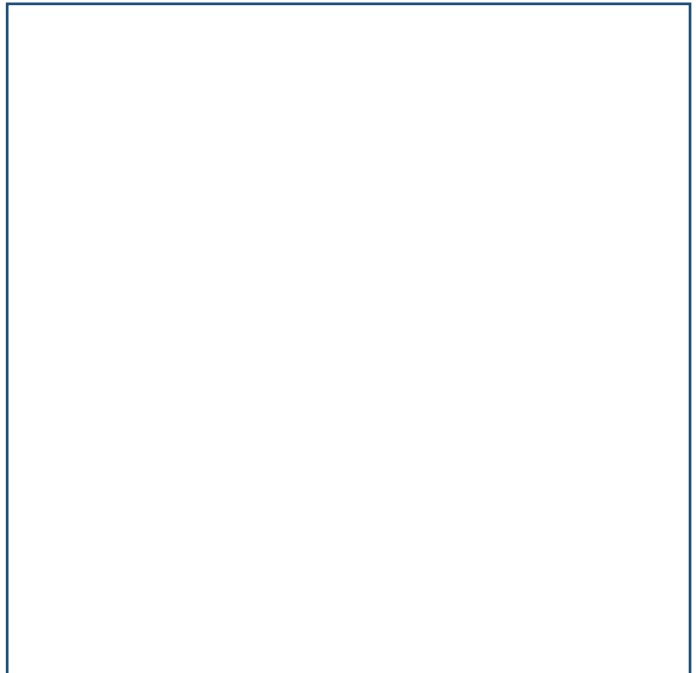

testo:



COMUNE DI BARGA - REGOLAMENTO URBANISTICO
ALLEGATO "B" ALLE NORME TECNICHE DI ATTUAZIONE
DISCIPLINA DEI CENTRI STORICI
ABACO DI RIFERIMENTO PER I CENTRI STORICI



ELEMENTO DI FACCIATA
SPECIFICHE

PORTALI

PORTALI E FORME APERTURE

N° EL. 04

schema grafico esempio 1



testo:

schema grafico esempio 2



testo:

schema grafico esempio 3



testo:

schema grafico esempio 4



testo:



**COMUNE DI BARGA - REGOLAMENTO URBANISTICO
ALLEGATO "B" ALLE NORME TECNICHE DI ATTUAZIONE
DISCIPLINA DEI CENTRI STORICI
ABACO DI RIFERIMENTO PER I CENTRI STORICI**



**ELEMENTO DI FACCIATA
SPECIFICHE**

PORTALI

PORTALI E FORME APERTURE

N° EL. 04

schema grafico esempio 5



testo:

schema grafico esempio 6



testo:

schema grafico esempio 7



testo:

schema grafico esempio 8



testo:



**COMUNE DI BARGA - REGOLAMENTO URBANISTICO
ALLEGATO "B" ALLE NORME TECNICHE DI ATTUAZIONE
DISCIPLINA DEI CENTRI STORICI
ABACO DI RIFERIMENTO PER I CENTRI STORICI**



**ELEMENTO DI FACCIATA
SPECIFICHE**

PORTALI

PORTALI E FORME APERTURE (EDIFICI RELIGIOSI)

N° EL. 04

schema grafico esempio 1

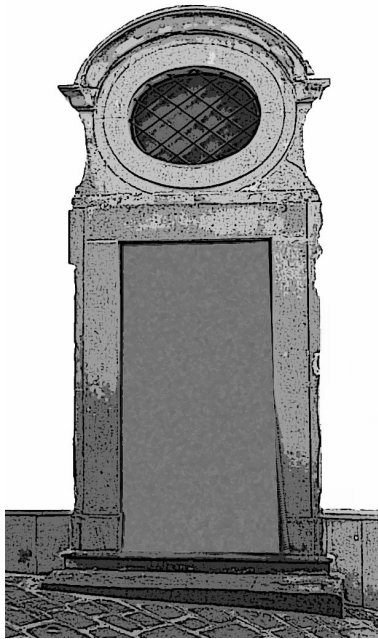

testo:

schema grafico esempio 2

testo:

schema grafico esempio 3

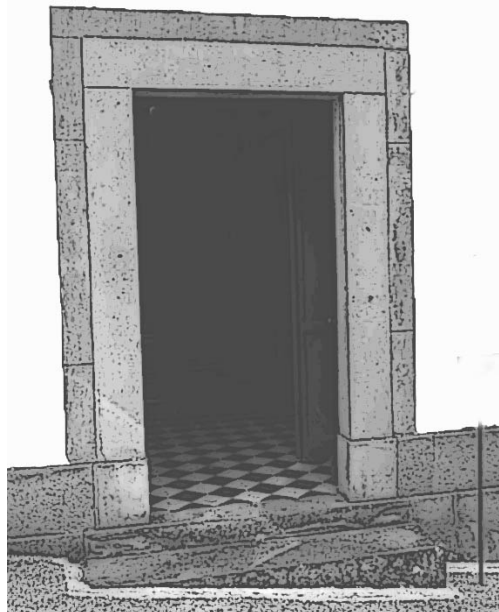

testo:

schema grafico esempio 4

testo:



**COMUNE DI BARGA - REGOLAMENTO URBANISTICO
ALLEGATO "B" ALLE NORME TECNICHE DI ATTUAZIONE
DISCIPLINA DEI CENTRI STORICI
ABACO DI RIFERIMENTO PER I CENTRI STORICI**



**ELEMENTO DI FACCIATA
SPECIFICHE**

PORTALI

PORTALI E FORME APERTURE (EDIFICI RELIGIOSI)

N° EL. 04

schema grafico esempio 5



testo:

schema grafico esempio 6



testo:

schema grafico esempio 7

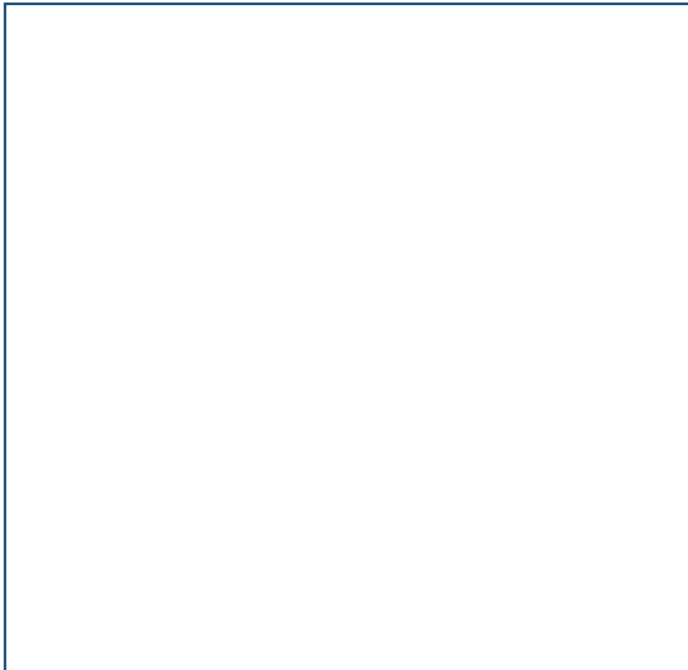

testo:

schema grafico esempio 8

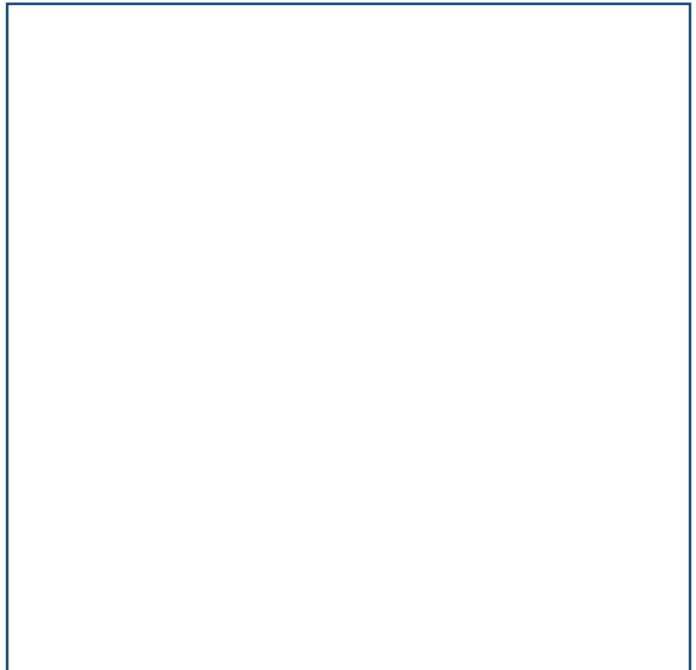

testo:



**COMUNE DI BARGA - REGOLAMENTO URBANISTICO
ALLEGATO "B" ALLE NORME TECNICHE DI ATTUAZIONE
DISCIPLINA DEI CENTRI STORICI
ABACO DI RIFERIMENTO PER I CENTRI STORICI**



**ELEMENTO DI FACCIATA
SPECIFICHE**

INFERRIATE

N° EL. 05

schema grafico esempio 1

schema grafico esempio 2

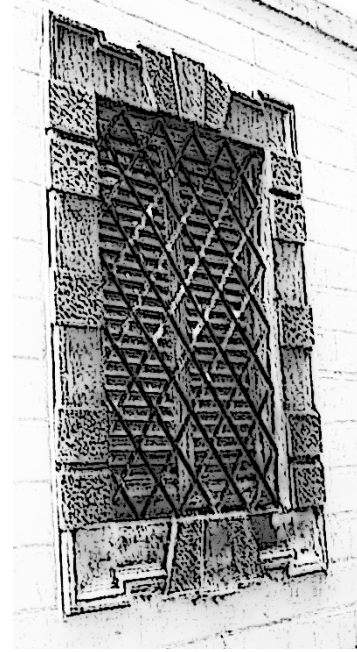
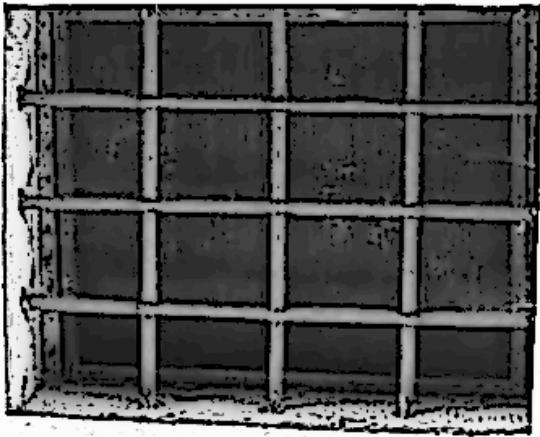

testo:

testo:

schema grafico esempio 3

schema grafico esempio 4

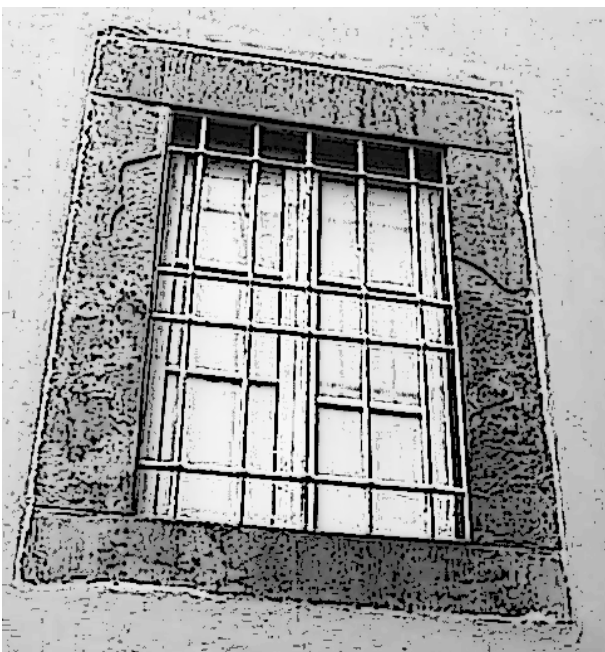

testo:

testo:



**COMUNE DI BARGA - REGOLAMENTO URBANISTICO
ALLEGATO "B" ALLE NORME TECNICHE DI ATTUAZIONE
DISCIPLINA DEI CENTRI STORICI
ABACO DI RIFERIMENTO PER I CENTRI STORICI**



**ELEMENTO DI FACCIATA
SPECIFICHE**

INFERRIATE

N° EL. 05

schema grafico esempio 5



testo:

schema grafico esempio 6



testo:

schema grafico esempio 7

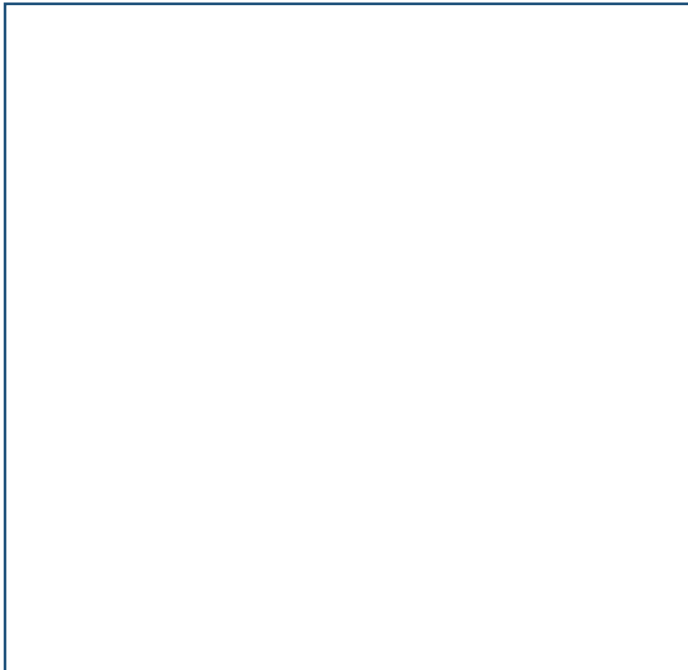

testo:

schema grafico esempio 8

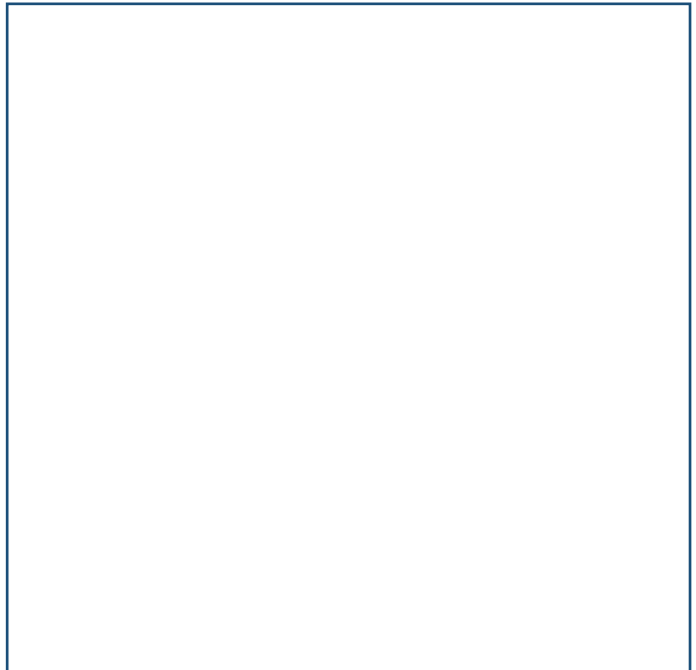

testo:



**COMUNE DI BARGA - REGOLAMENTO URBANISTICO
ALLEGATO "B" ALLE NORME TECNICHE DI ATTUAZIONE
DISCIPLINA DEI CENTRI STORICI
ABACO DI RIFERIMENTO PER I CENTRI STORICI**



ELEMENTO DI FACCIATA
SPECIFICHE

CORNICI ALLE FINESTRE

PIANO TERRA E FORME APERTURE

N° EL. 06

schema grafico esempio 1



testo:

schema grafico esempio 2

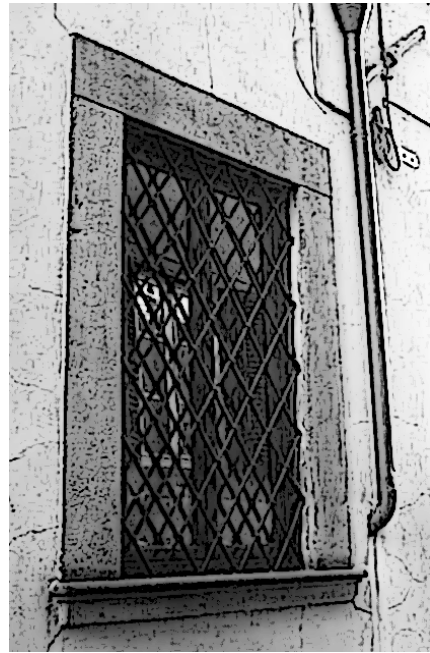

testo:

schema grafico esempio 3



testo:

schema grafico esempio 4



testo:



**COMUNE DI BARGA - REGOLAMENTO URBANISTICO
ALLEGATO "B" ALLE NORME TECNICHE DI ATTUAZIONE
DISCIPLINA DEI CENTRI STORICI
ABACO DI RIFERIMENTO PER I CENTRI STORICI**



ELEMENTO DI FACCIATA
SPECIFICHE

CORNICI ALLE FINESTRE

PIANO TERRA E FORME APERTURE

N° EL. 06

schema grafico esempio 5

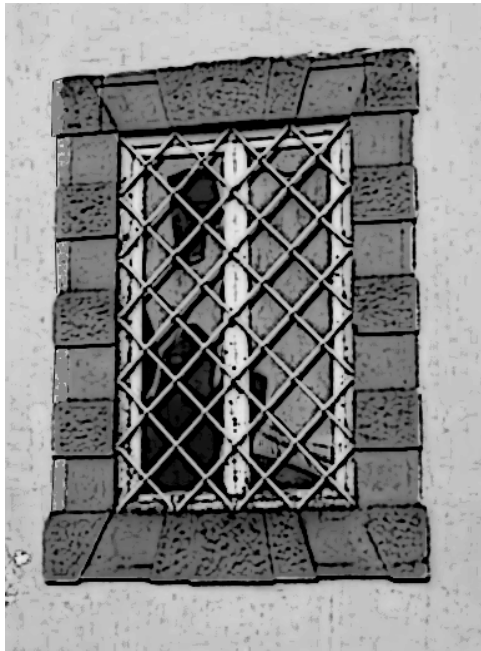

testo:

schema grafico esempio 6



testo:

schema grafico esempio 7



testo:

schema grafico esempio 8



testo:



**COMUNE DI BARGA - REGOLAMENTO URBANISTICO
ALLEGATO "B" ALLE NORME TECNICHE DI ATTUAZIONE
DISCIPLINA DEI CENTRI STORICI
ABACO DI RIFERIMENTO PER I CENTRI STORICI**



**ELEMENTO DI FACCIATA
SPECIFICHE**

CORNICI ALLE FINESTRE

PIANI SUPERIORI E FORME APERTURE

N° EL. 06

schema grafico esempio 1



testo:

schema grafico esempio 2

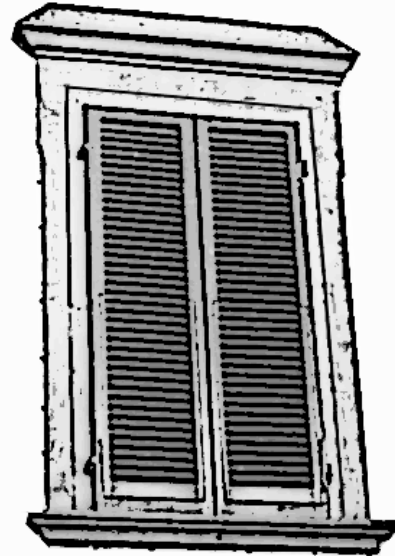

testo:

schema grafico esempio 3



testo:

schema grafico esempio 4



testo:



**COMUNE DI BARGA - REGOLAMENTO URBANISTICO
ALLEGATO "B" ALLE NORME TECNICHE DI ATTUAZIONE
DISCIPLINA DEI CENTRI STORICI
ABACO DI RIFERIMENTO PER I CENTRI STORICI**



**ELEMENTO DI FACCIATA
SPECIFICHE**

CORNICI ALLE FINESTRE

PIANI SUPERIORI E FORME APERTURE

N° EL. 06

schema grafico esempio 5

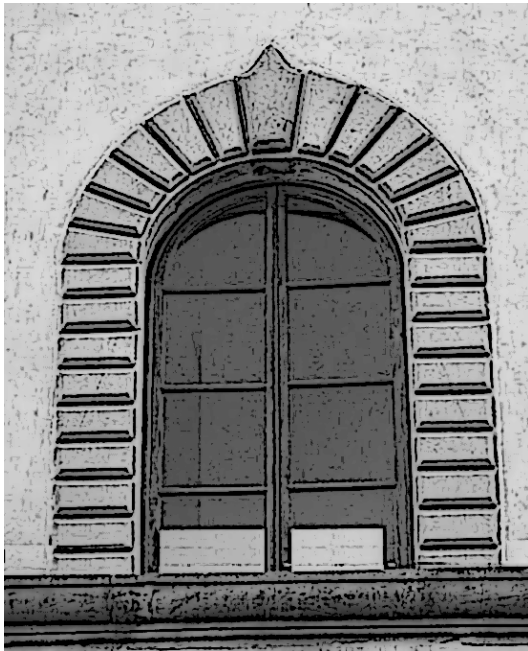

schema grafico esempio 6



testo:

testo:

schema grafico esempio 7

schema grafico esempio 8

testo:

testo:



**COMUNE DI BARGA - REGOLAMENTO URBANISTICO
ALLEGATO "B" ALLE NORME TECNICHE DI ATTUAZIONE
DISCIPLINA DEI CENTRI STORICI
ABACO DI RIFERIMENTO PER I CENTRI STORICI**



ELEMENTO DI FACCIATA
SPECIFICHE

CORNICI ALLE FINESTRE

SOTTOTETTO/ULTIMO PIANO E FORME APERTURE

N° EL. 06

schema grafico esempio 1

schema grafico esempio 2

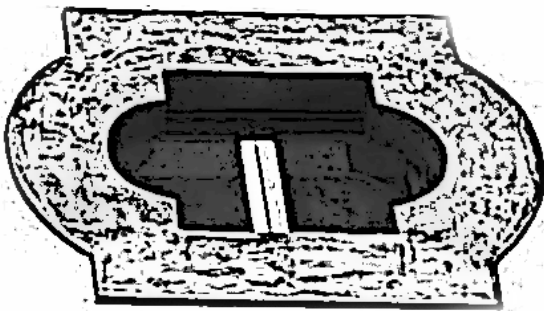

testo:

testo:

schema grafico esempio 3

schema grafico esempio 4



testo:

testo:



**COMUNE DI BARGA - REGOLAMENTO URBANISTICO
ALLEGATO "B" ALLE NORME TECNICHE DI ATTUAZIONE
DISCIPLINA DEI CENTRI STORICI
ABACO DI RIFERIMENTO PER I CENTRI STORICI**



**ELEMENTO DI FACCIATA
SPECIFICHE**

DISPOSITIVI OSCURANTI

N° EL. 07

schema grafico esempio 1



testo:

schema grafico esempio 2



testo:

schema grafico esempio 3

schema grafico esempio 4

testo:

testo:



**COMUNE DI BARGA - REGOLAMENTO URBANISTICO
ALLEGATO "B" ALLE NORME TECNICHE DI ATTUAZIONE
DISCIPLINA DEI CENTRI STORICI
ABACO DI RIFERIMENTO PER I CENTRI STORICI**



**ELEMENTO DI FACCIATA
SPECIFICHE**

INFISSI

PORTE E PORTONI

N° EL. 08

schema grafico esempio 1



testo:

schema grafico esempio 2



testo:

schema grafico esempio 3



testo:

schema grafico esempio 4



testo:



**COMUNE DI BARGA - REGOLAMENTO URBANISTICO
ALLEGATO "B" ALLE NORME TECNICHE DI ATTUAZIONE
DISCIPLINA DEI CENTRI STORICI
ABACO DI RIFERIMENTO PER I CENTRI STORICI**



**ELEMENTO DI FACCIATA
SPECIFICHE**

INFISSI

PORTE E PORTONI **N° EL. 08**

schema grafico esempio 5

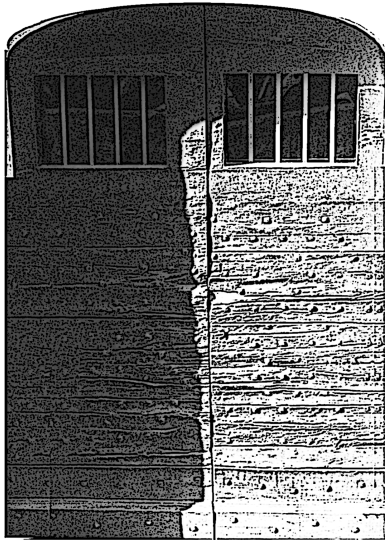

schema grafico esempio 6

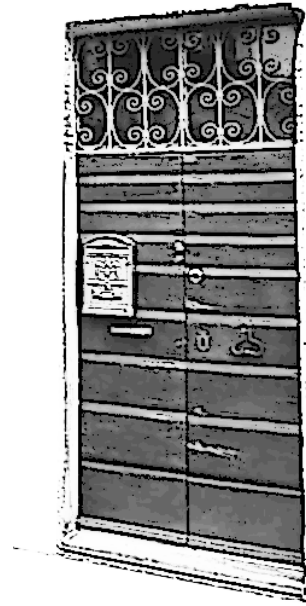

testo:

testo:

schema grafico esempio 7



schema grafico esempio 8



testo:

testo:



**COMUNE DI BARGA - REGOLAMENTO URBANISTICO
ALLEGATO "B" ALLE NORME TECNICHE DI ATTUAZIONE
DISCIPLINA DEI CENTRI STORICI
ABACO DI RIFERIMENTO PER I CENTRI STORICI**



**ELEMENTO DI FACCIATA
SPECIFICHE**

INFISSI

FINESTRE

N° EL. 08

schema grafico esempio 1



testo:

schema grafico esempio 2



testo:

schema grafico esempio 3



testo:

schema grafico esempio 4



testo:



**COMUNE DI BARGA - REGOLAMENTO URBANISTICO
ALLEGATO "B" ALLE NORME TECNICHE DI ATTUAZIONE
DISCIPLINA DEI CENTRI STORICI
ABACO DI RIFERIMENTO PER I CENTRI STORICI**



**ELEMENTO DI FACCIATA
SPECIFICHE**

INFISSI

FINESTRE

N° EL. 08

schema grafico esempio 5



testo:

schema grafico esempio 6



testo:

schema grafico esempio 7



testo:

schema grafico esempio 8

testo:



**COMUNE DI BARGA - REGOLAMENTO URBANISTICO
ALLEGATO "B" ALLE NORME TECNICHE DI ATTUAZIONE
DISCIPLINA DEI CENTRI STORICI
ABACO DI RIFERIMENTO PER I CENTRI STORICI**



**ELEMENTO DI FACCIATA
SPECIFICHE**

BALCONI/RINGHIERE/PARAPETTI

N° EL. 11

schema grafico esempio 1



testo:

schema grafico esempio 2

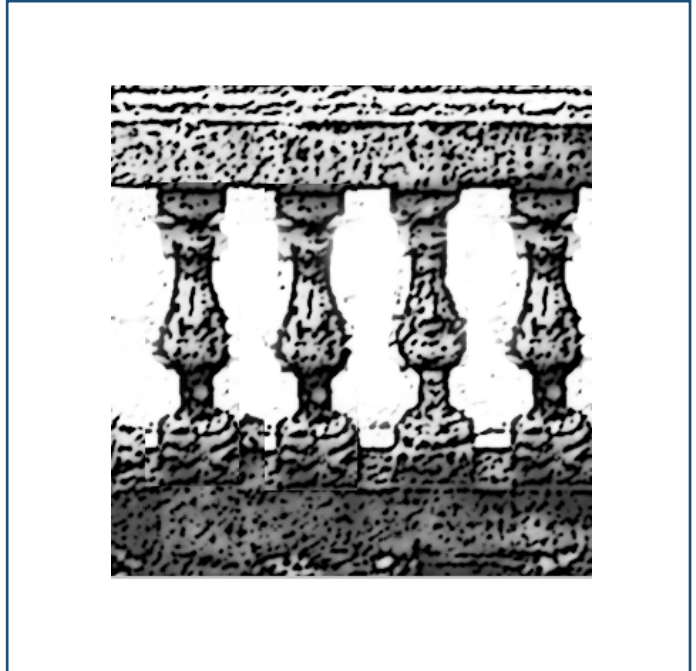

testo:

schema grafico esempio 3



testo:

schema grafico esempio 4



testo:



**COMUNE DI BARGA - REGOLAMENTO URBANISTICO
ALLEGATO "B" ALLE NORME TECNICHE DI ATTUAZIONE
DISCIPLINA DEI CENTRI STORICI
ABACO DI RIFERIMENTO PER I CENTRI STORICI**



**ELEMENTO DI FACCIATA
SPECIFICHE**

BALCONI/RINGHIERE/PARAPETTI

N° EL. 11

schema grafico esempio 5



testo:

schema grafico esempio 6



testo:

schema grafico esempio 7



testo:

schema grafico esempio 8



testo:



COMUNE DI BARGA - REGOLAMENTO URBANISTICO
ALLEGATO "B" ALLE NORME TECNICHE DI ATTUAZIONE
DISCIPLINA DEI CENTRI STORICI
ABACO DI RIFERIMENTO PER I CENTRI STORICI



ELEMENTO DI FACCIATA
SPECIFICHE

CORNICI

N° EL. 13

schema grafico esempio 1

schema grafico esempio 2

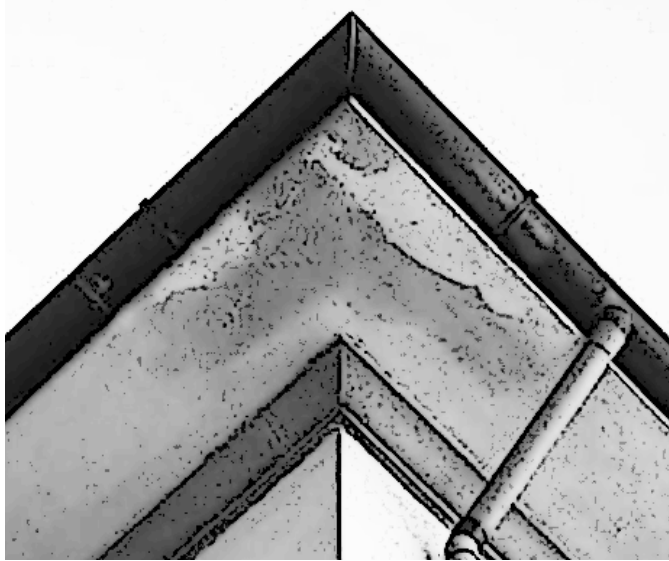

testo:

testo:

schema grafico esempio 3

schema grafico esempio 4

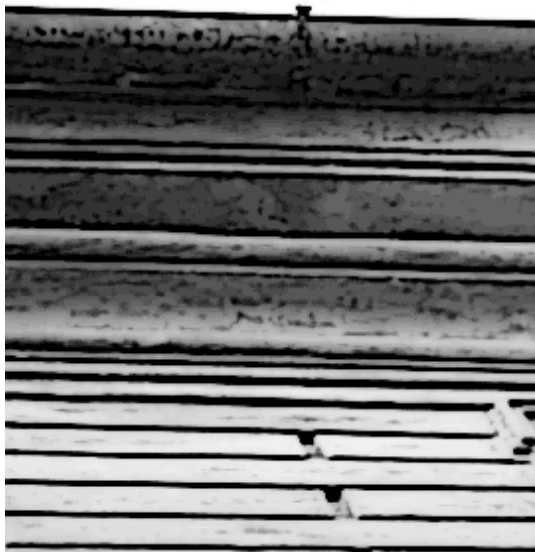

testo:

testo:



**COMUNE DI BARGA - REGOLAMENTO URBANISTICO
ALLEGATO "B" ALLE NORME TECNICHE DI ATTUAZIONE
DISCIPLINA DEI CENTRI STORICI
ABACO DI RIFERIMENTO PER I CENTRI STORICI**



**ELEMENTO DI FACCIATA
SPECIFICHE**

CORNICIONI

N° EL. 13

schema grafico esempio 5



schema grafico esempio 6

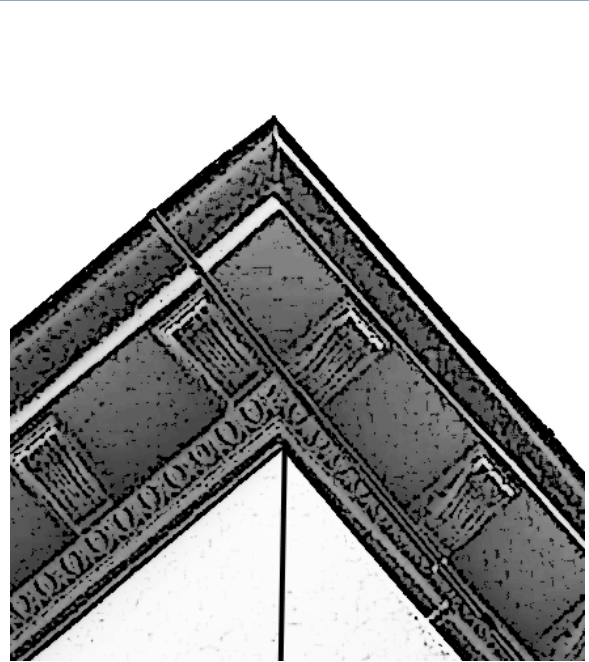

testo:

testo:

schema grafico esempio 7

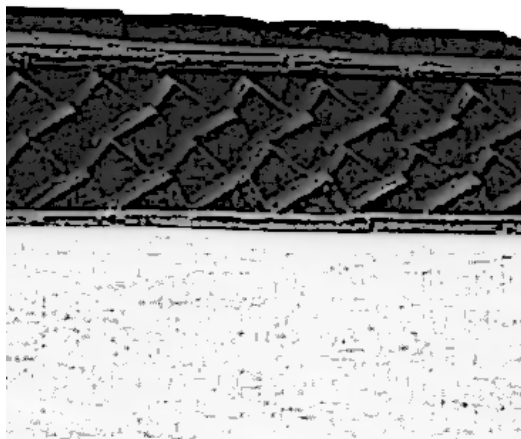

schema grafico esempio 8



testo:

testo:



COMUNE DI BARGA - REGOLAMENTO URBANISTICO
ALLEGATO "B" ALLE NORME TECNICHE DI ATTUAZIONE
DISCIPLINA DEI CENTRI STORICI
ABACO DI RIFERIMENTO PER I CENTRI STORICI



ELEMENTO DI FACCIATA
SPECIFICHE

SOTTOGRONDA

N° EL. 14

schema grafico esempio 1

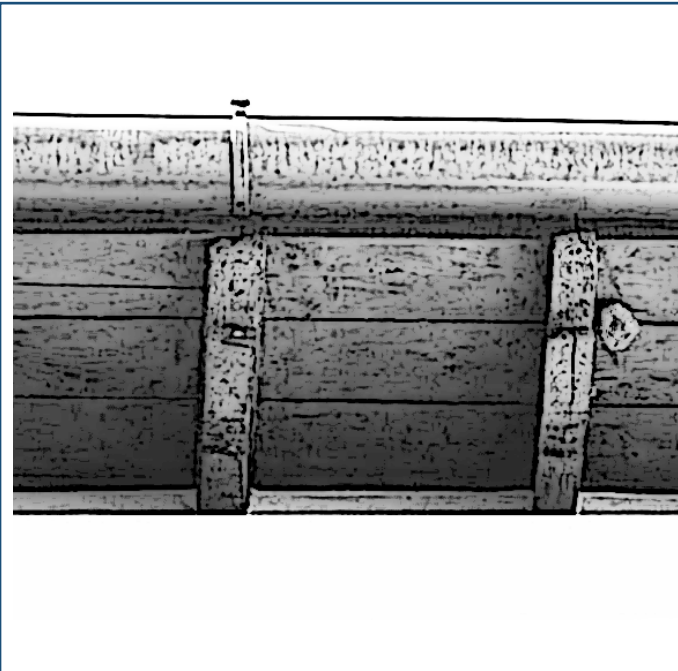

testo:

schema grafico esempio 2

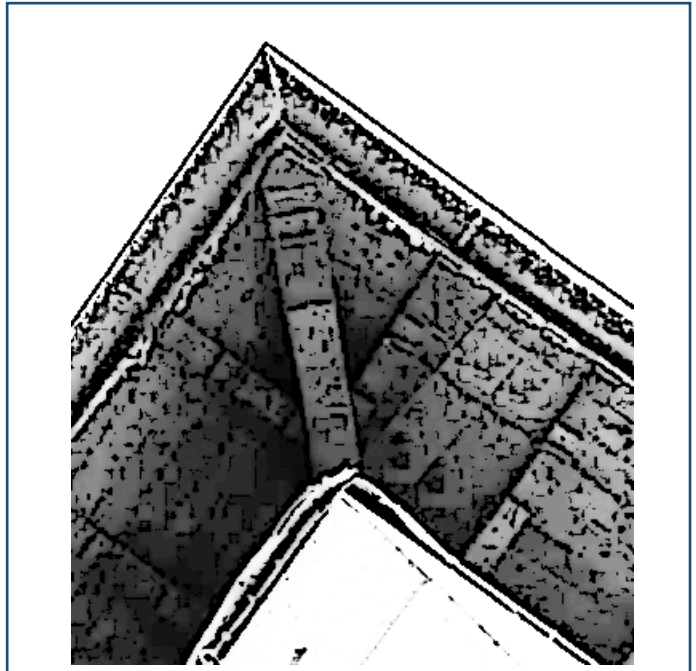

testo:

schema grafico esempio 3

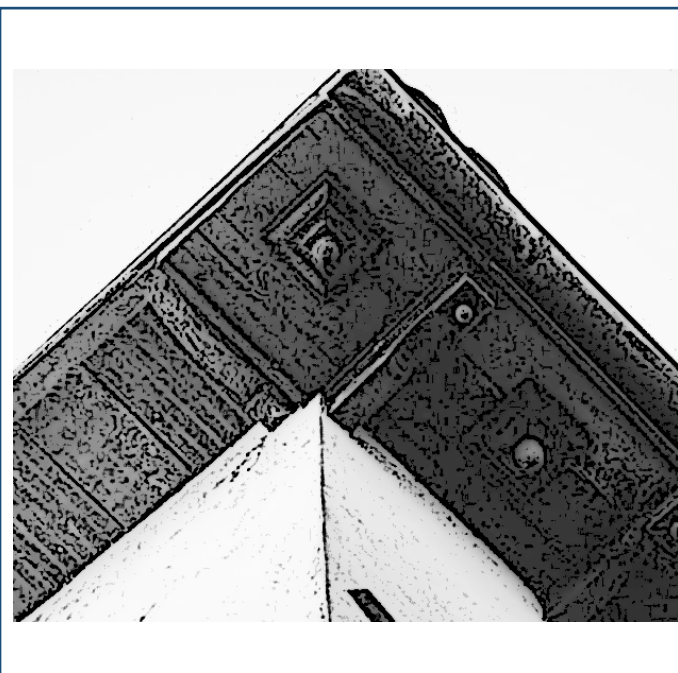

testo:

schema grafico esempio 4

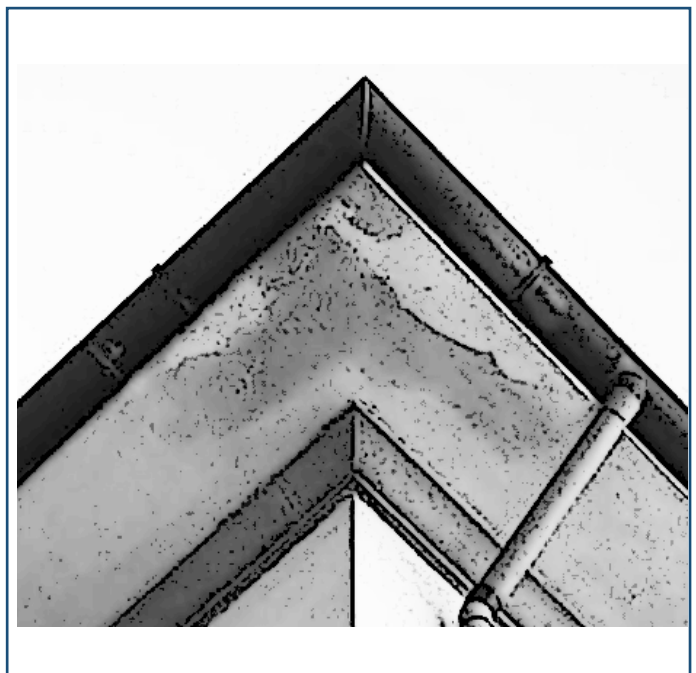

testo:



**COMUNE DI BARGA - REGOLAMENTO URBANISTICO
ALLEGATO "B" ALLE NORME TECNICHE DI ATTUAZIONE
DISCIPLINA DEI CENTRI STORICI
ABACO DI RIFERIMENTO PER I CENTRI STORICI**



**ELEMENTO DI FACCIATA
SPECIFICHE**

SOTTOGRONDA

N° EL. 14

schema grafico esempio 5

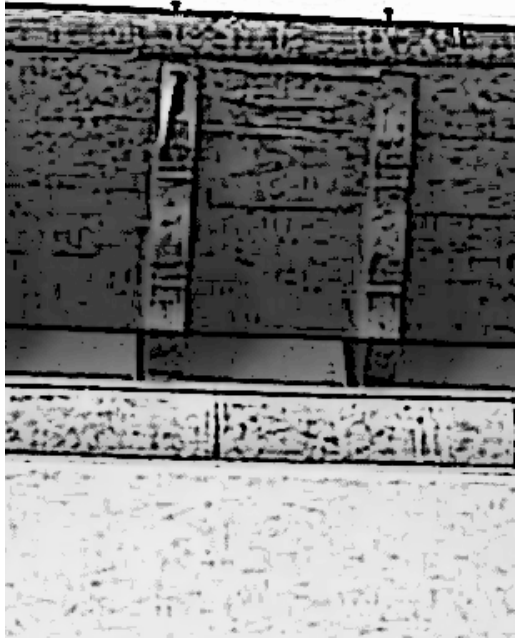

testo:

schema grafico esempio 6



testo:

schema grafico esempio 7

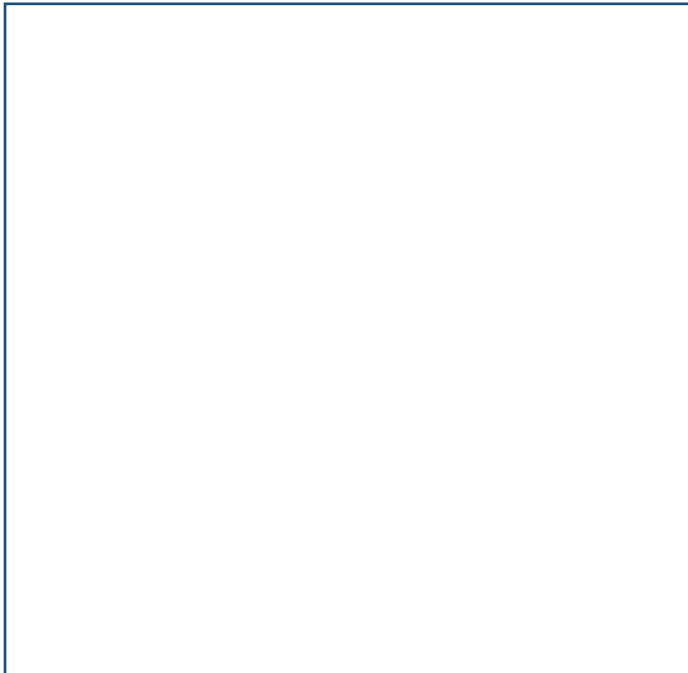

testo:

schema grafico esempio 8

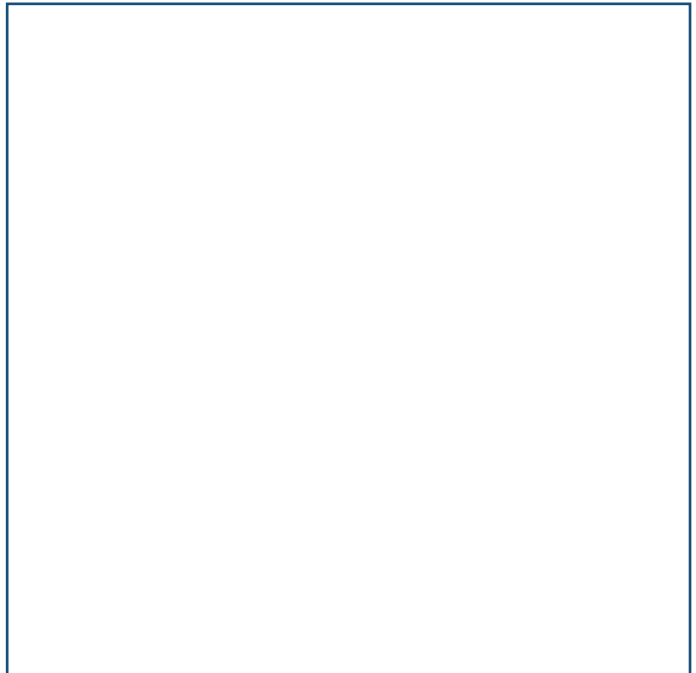

testo:



**COMUNE DI BARGA - REGOLAMENTO URBANISTICO
ALLEGATO "B" ALLE NORME TECNICHE DI ATTUAZIONE
DISCIPLINA DEI CENTRI STORICI
ABACO DI RIFERIMENTO PER I CENTRI STORICI**



**ELEMENTO DI FACCIATA
SPECIFICHE**

COMIGNOLI E CANNE FUMARIE

N° EL. 16

schema grafico esempio 1

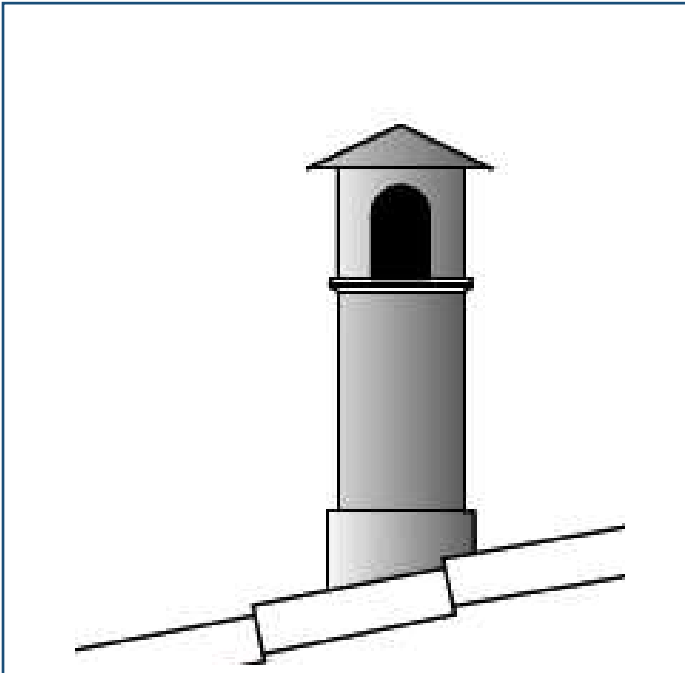

testo:

schema grafico esempio 2

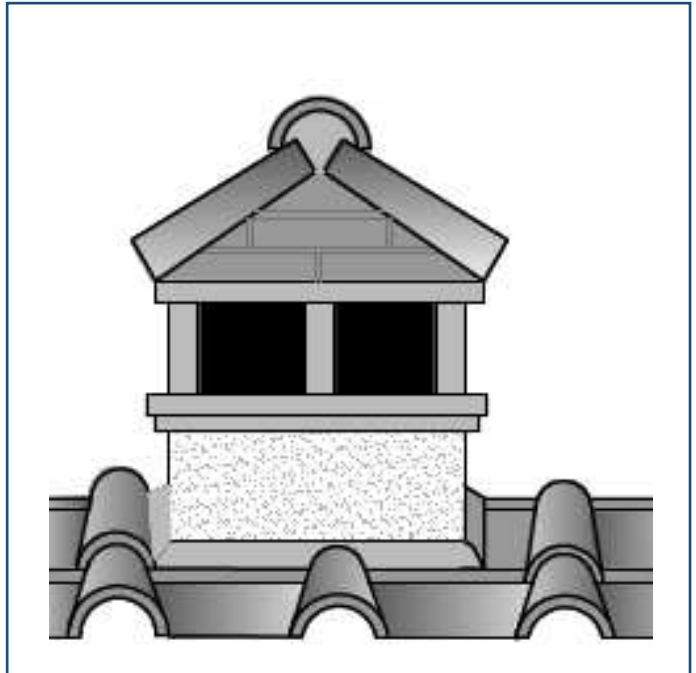

testo:

schema grafico esempio 3

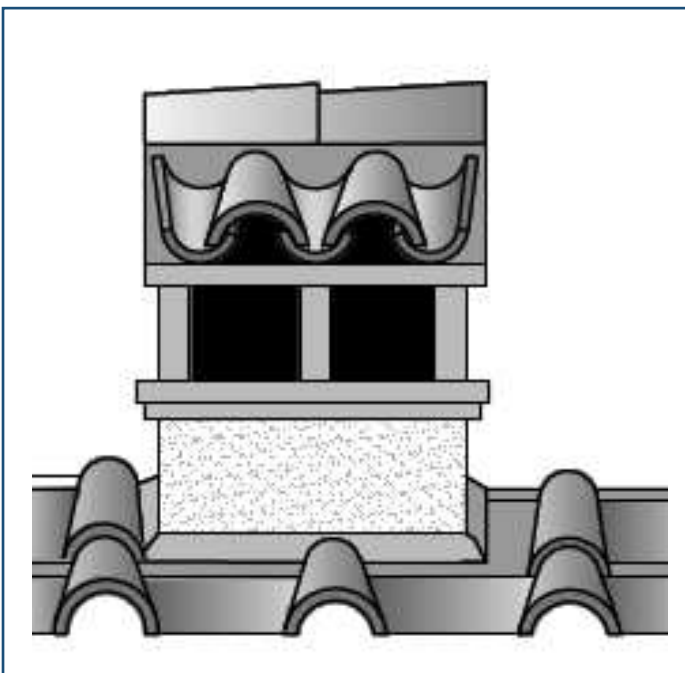

testo:

schema grafico esempio 4

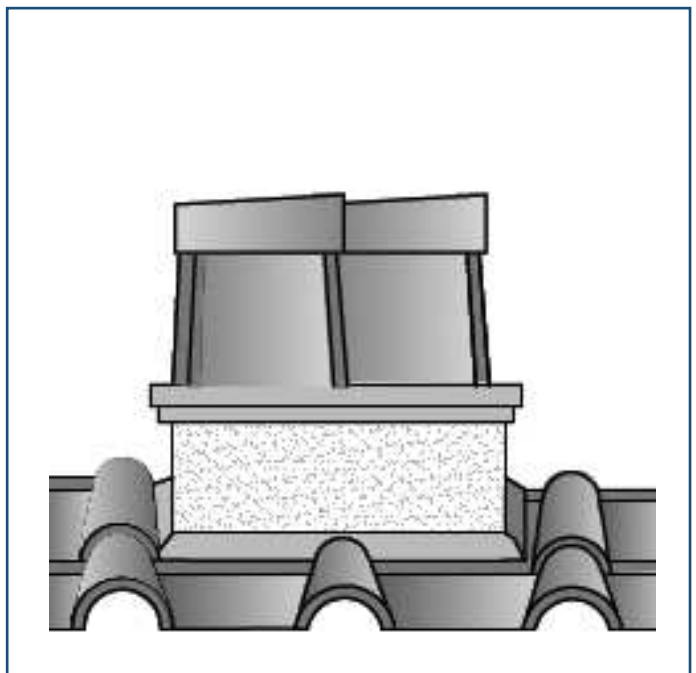

testo:



**COMUNE DI BARGA - REGOLAMENTO URBANISTICO
ALLEGATO "B" ALLE NORME TECNICHE DI ATTUAZIONE
DISCIPLINA DEI CENTRI STORICI
ABACO DI RIFERIMENTO PER I CENTRI STORICI**



**ELEMENTO DI FACCIATA
SPECIFICHE**

COMIGNOLI E CANNE FUMARIE

N° EL. 16

schema grafico esempio 5

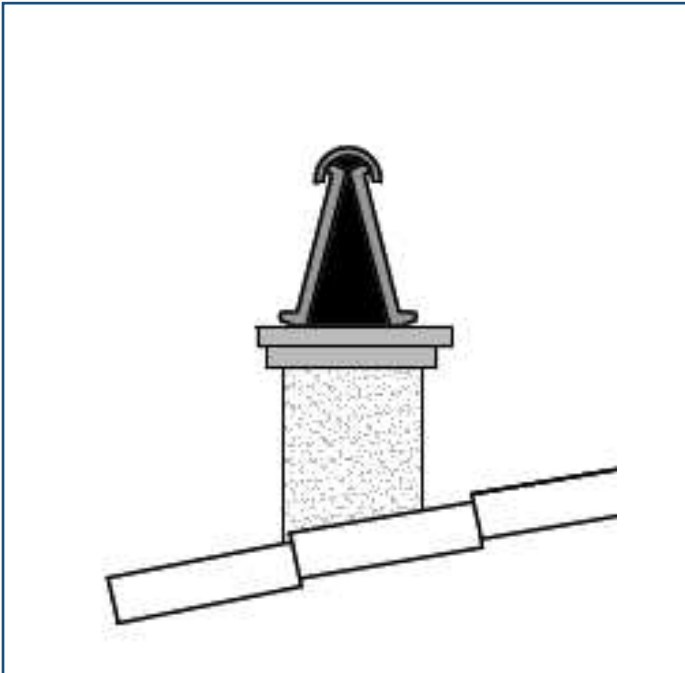

testo:

schema grafico esempio 6

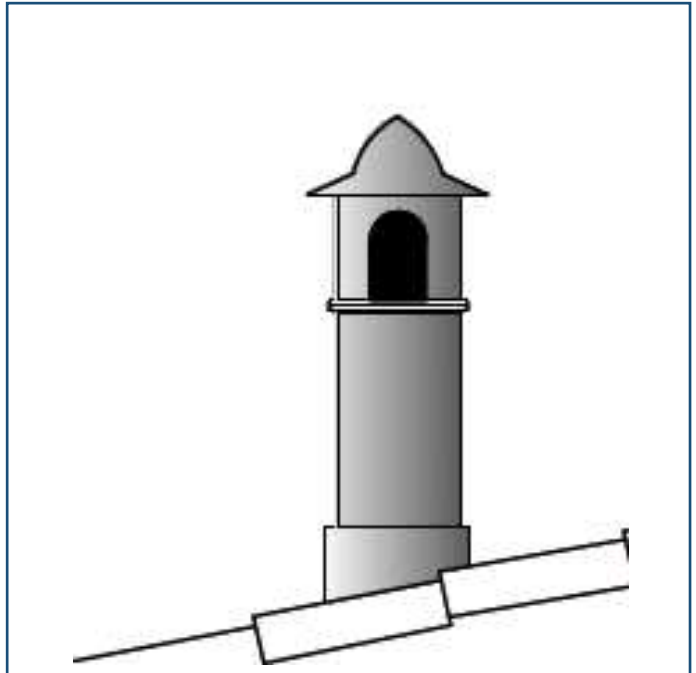

testo:

schema grafico esempio 7

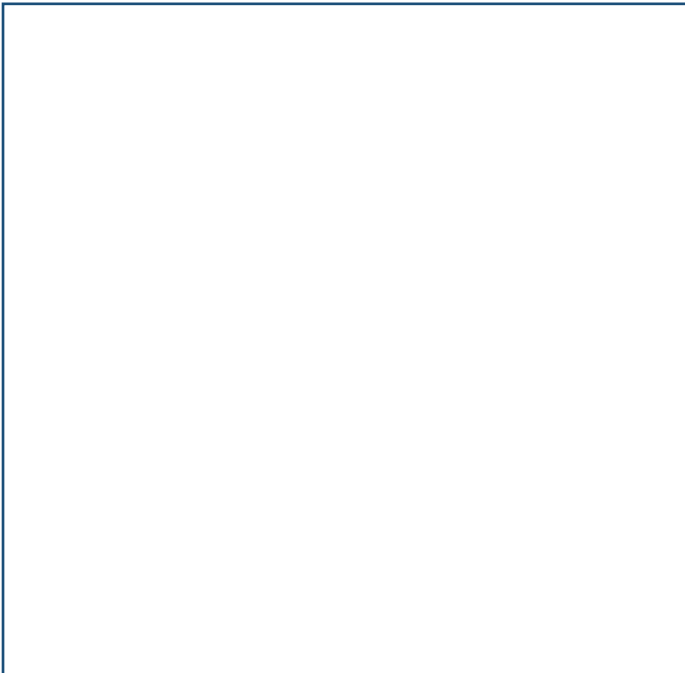

testo:

schema grafico esempio 8

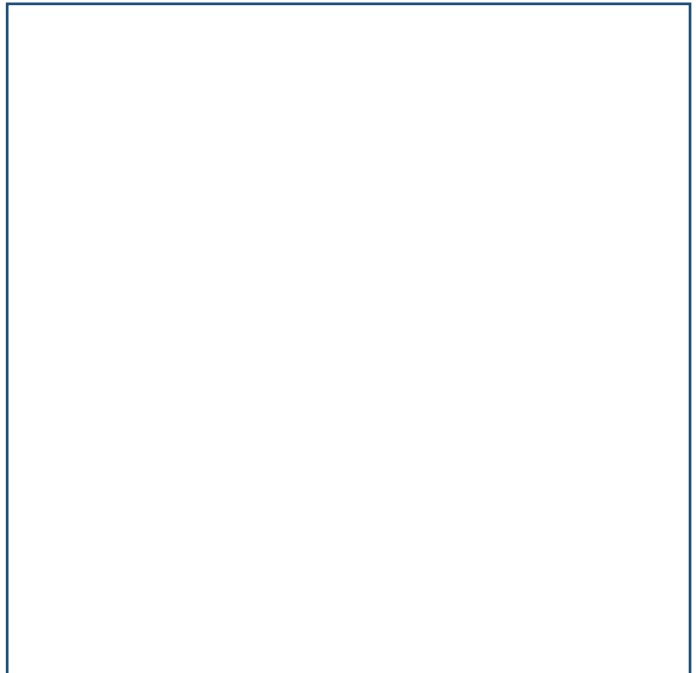

testo: